



# INVERTER SERIES HIGH PERFORMANCE VECTOR CONTROL A1000



EN  
DE  
ES  
FR  
IT

A1000  
A1000  
A1000  
A1000

# A1000

## YASKAWA A1000 HIGH PERFORMANCE DRIVE

### Contents

- ▶ **Page 2**  
Experience & Innovation  
A leader in Inverter Drives technology  
Main Features
- ▶ **Page 3**  
Customize Your Drive
- ▶ **Page 4/5**  
Permanent Magnet Motor Control
- ▶ **Page 6/7**  
Safety Features & Communication
- ▶ **Page 8/9**  
Easy start-up and reliable operation
- ▶ **Page 10/11**  
Drive Design & Features
- ▶ **Page 12**  
Efficiency & Environment
- ▶ **Page 13**  
Specifications
- ▶ **Page 14**  
Connection Diagram
- ▶ **Page 15**  
Terminal Functions
- ▶ **Page 16/17**  
Dimensions
- ▶ **Page 18**  
Options
- ▶ **Page 19**  
Ratings & Type Descriptions

### Experience & Innovation

For more than 90 years YASKAWA has been manufacturing and supplying mechatronic products for machine building and industrial automation. Its standard products as well as tailor-made solutions are famous and have a high reputation for outstanding quality and durability.

### A leader in Inverter Drives technology

Extensive research and development has allowed YASKAWA to remain at the forefront of motion control and automation technology. This technological leadership has helped to modernise industries such as mining, steel, pulp and paper, chemical, automotive, packaging, machine tool and semiconductor.

In 2007 YASKAWA produced its 10 millionth inverter in the new inverter plant in Yukuhashi, Japan. By this YASKAWA is probably the biggest inverter manufacturer in the world.

With the new A1000, YASKAWA continues its tradition of developing innovative solutions in drive technology. The A1000 provides remarkable advantages through excellent motor drive performance, environmental benefits and energy savings as well as many user orientated operational features. Moreover, the A1000 offers advanced characteristics that are included as standard.

In response to the needs of users, we have introduced next-generation product features to A1000 vector control technology:

### Main Features:

- ▶ **For Induction Motor and Permanent Magnet Motor Control:**  
The A1000 is a premium inverter drive for a wide field of applications including great advantages in more than one way
- ▶ **Providing newest Safety Features:**  
Safety features of the A1000 comply with today's market safety requirements and standards
- ▶ **For Easy Start-up and Reliable Operation:**  
YASKAWA A1000 provides significant costs reduction potentials during installation and operation
- ▶ **Improved Drive Design & Functions:**  
Small size and application oriented design improve performance, reliability and performance life
- ▶ **Enhanced Efficiency & Environment:**  
Using the A1000 saves energy and reduces audible noise

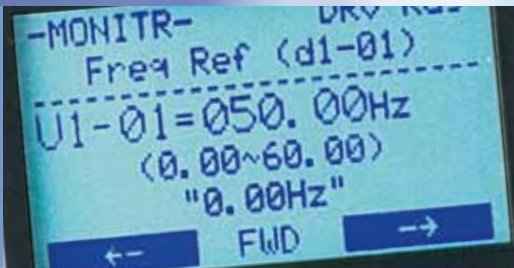

### Permanent Magnet Motor Control

- ▶ Open loop position control (No Motor Feedback)
- ▶ 200% rated torque at 0 rpm
- ▶ New Auto-Tuning Features

### Safety Features & Communication

- ▶ Functional Safety: A1000 provides Safe Torque Off (STO) in compliance with EN ISO 13849-1, Cat. 3, PLd, IEC/EN61508 SIL2
- ▶ External Device Monitor (EDM) to Observe the Safety Status

### Easy Start-up & Reliable Operation

- ▶ Application Parameter Presets
- ▶ Screwless Removable Control Terminal with Parameter Backup
- ▶ Online Auto-Tuning for Motor Parameter
- ▶ Tuning of the Speed Loop according to Load
- ▶ Parameter Copy and Backup Function
- ▶ Engineering Tool DriveWizard Plus for Parameter Management
- ▶ Application SW Library
- ▶ Performance Life Diagnostics for all major inverter components

### Drive Design & Functions

- ▶ Extremely compact
- ▶ Space saving Side-by-Side Mounting
- ▶ Dual Rating for Cost & Space Saving
- ▶ Long Performance Life

### Efficiency & Environment

- ▶ Advanced Energy Saving Functionality
- ▶ Unique PWM function reduces audible noise.
- ▶ Minimum Power Loss in Normal Duty Rating

## Customize Your Drive

- ▶ DriveWorksEZ visual programming tool. Simply drag and drop icons to customize your drive. Create special sequences and detection functions, then load them onto the drive.

### Program a customized sequence

- ▶ Example: Sensorless positioning control function

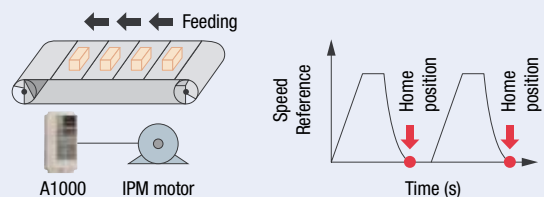

### Create customized detection features

- ▶ Example: Machine weakening analysis using torque pulse detection

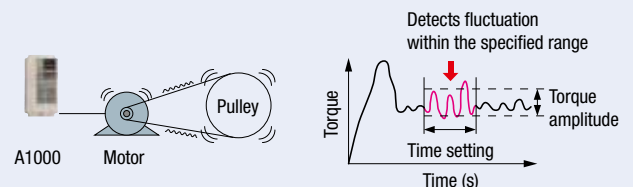

### Built in USB port lets the drive connect to a PC



**Note:** Drives are also equipped with an RJ-45 comm. port that takes the existing WV103 cable used in YASKAWA's previous models. Simply remove the operator keypad for access to the RJ-45 connector.



## Advanced Motor Control

### Advanced Drive Technology

- ▶ Capable of driving different types of motor. A1000 runs not only induction motors, but also synchronous motors like IPM\*<sup>1</sup> and SPM\*<sup>2</sup> motors with high performance open and closed loop vector control.
- ▶ Minimize equipment needed for your business by using the same drive to run induction and synchronous motors.

\*1 Interior Permanent Magnet Motor  
(Motors with permanent magnets inserted into the rotor)  
\*2 Surface Mounted Permanent Magnet Motor  
(Motors with permanent magnets mounted on the surface of the rotor)

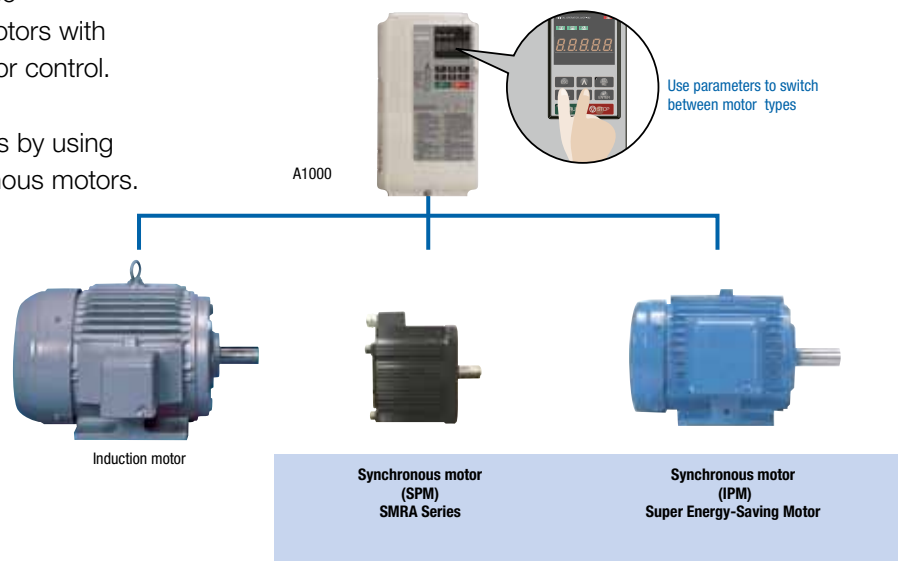

### Positioning Capability without External Devices

- ▶ Use an IPM motor to perform position control – without motor feedback. Electrical saliency in IPM motors makes it possible to detect speed, direction and rotor position without the use of external feedback devices.
- ▶ Positioning functionality without a PLC. Visual programming in DriveWorksEZ eliminates the need for external controllers by giving the user the power to create customized functions such as position control.

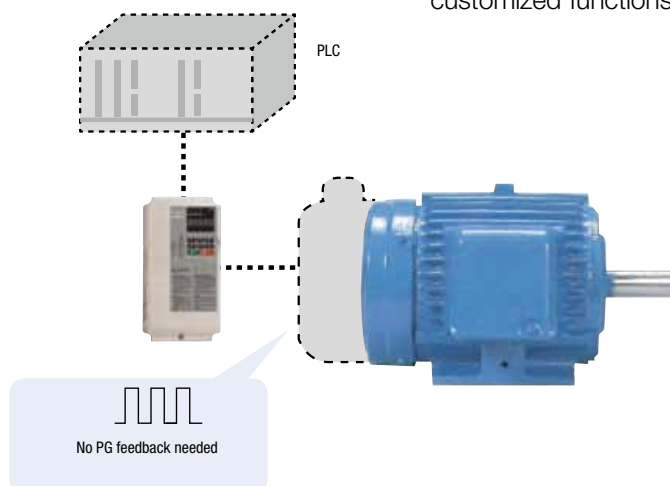



## New Auto-Tuning Features

- ▶ Auto-Tuning features optimize drive parameters for operation with induction motors as well as synchronous motors to achieve the highest performance levels possible.
- ▶ Optimizing not only the drive and motor performance, but also automatically adjusts settings relative to the connected machinery.
- ▶ New Auto-Tuning methods.  
A1000 continuously analyzes changes in motor characteristics during operation for highly precise speed control.

Tuning the Motor	
Rotational Auto-Tuning	Applications requiring high starting torque, high speed, and high accuracy.
Stationary Auto-Tuning	Applications where the motor must remain connected to the load during the tuning process.
Line-to-Line Resistance Auto-Tuning	For tuning after the cable length between the motor and drive has changed, or when motor and drive capacity ratings differ.
Energy-Saving Auto-Tuning	For running the motor at top efficiency all the time.

Tuning the Load	
ASR* Tuning	Perfects responsiveness relative to the machine. Until now, this tuning procedure was fairly time consuming to set.
Inertia Tuning	Optimizes the drive's ability to decelerate the load. Useful for applications using Kinetic Energy Buffering Function and Feed Forward functions.

\* Automatic Speed Regulator

## Powerful Torque Characteristics

- ▶ Powerful torque at 0 Hz, without sensors or feedback devices.  
Until recently, sensorless control has been out of reach for synchronous motors. Now A1000 provides powerful starting torque algorithm without relying on pole sensors or motor feedback.
- ▶ High-performance current vector control achieves powerful starting torque with an induction motor.

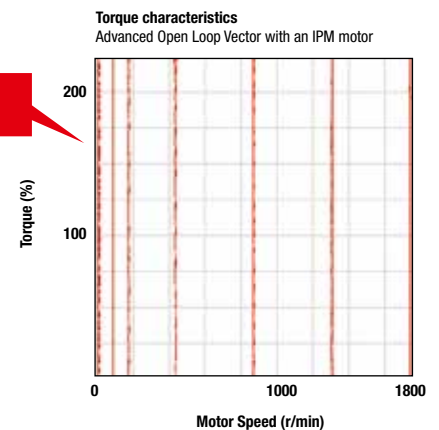

Synchronous Motor	
Advanced Open Loop Vector for PM motors	200% rated torque at 0 r/min*, speed range of 1:100*
Closed Loop Vector Control for PM motors	200% rated torque at 0 r/min, speed range of 1:1500

\* only IPM motor

Induction Motor	
Open Loop Vector Control	200% rated torque at 0.3 Hz*, speed range of 1:200
Closed Loop Vector Control	200% rated torque at 0 r/min*, speed range of 1:1500

\* Proper output torque depends on matching drive and motor capacity.

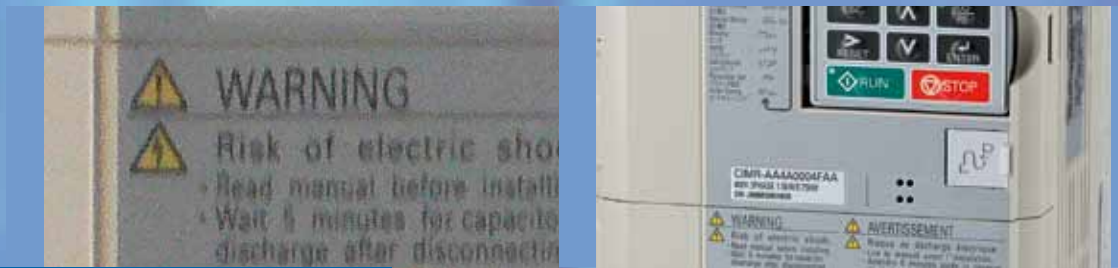

## Safety Features & Communication

### Power Loss & Recovery

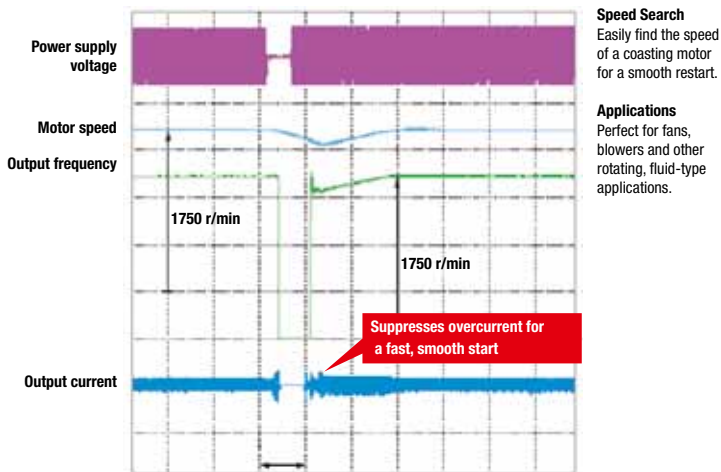

- ▶ A1000 offers two ways to handle momentary power loss
- ▶ A1000 is capable of handling momentary power loss with sensorless control for induction motors as well as for synchronous motors.
- ▶ A1000 lets you ride through a power loss for up to 2 seconds.\*

\* Option available for certain models.

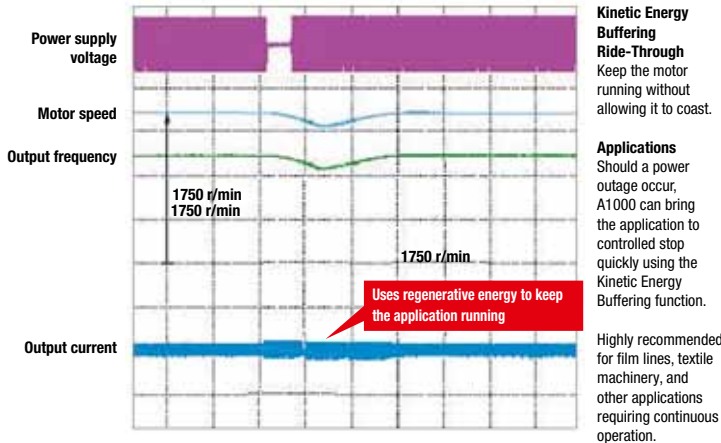

Note: Separate sensor to detect power loss are required.

### Protective Design

A variety of protective designs are available to reinforce the drive against moisture, dust, oil mist, vibration, corrosive sulfur gas, conductive particles, and other harsh environments.

- ▶ IP54, dust proof and splash-waterproof version (available soon)
- ▶ RoHS Compliance





## Safety Features as a Standard

- ▶ A1000 provides Safe Torque Off (STO) in compliance with EN ISO 13849-1, Cat. 3, PLd, IEC/EN61508 SIL2
- ▶ An External Device Monitor (EDM) function has also been added to monitor the safety status of the drive.

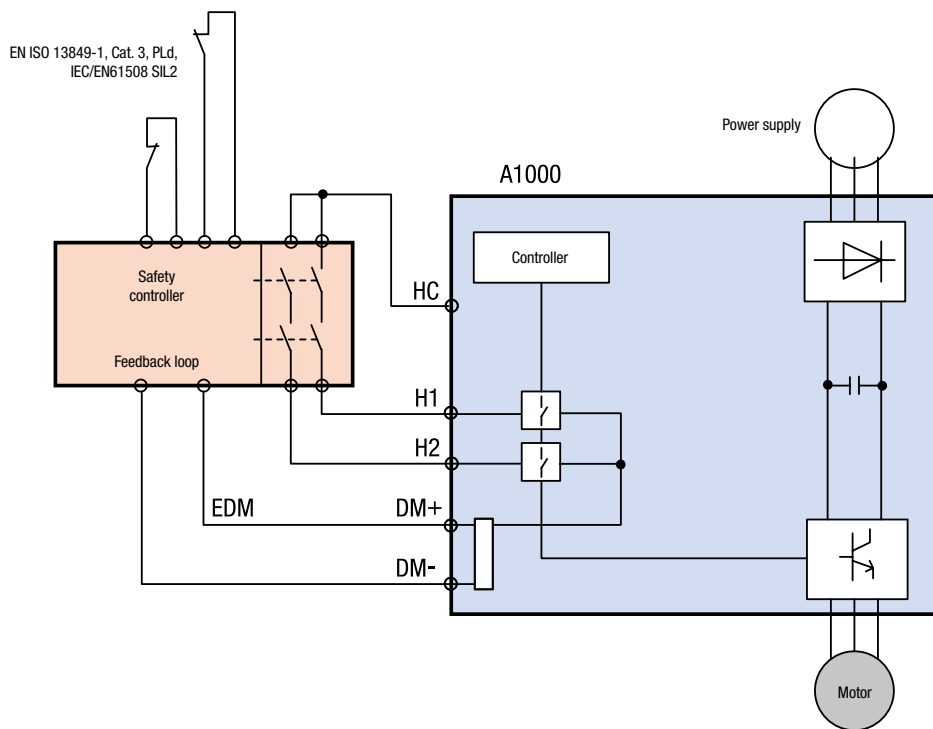

## All Major Serial Communication Protocols

- ▶ RS-422/485 (MEMOBUS/Modbus at 115.2 kbps) standard on all models.
- ▶ Option cards available for all major fieldbuses used across the globe:





## Easy start-up and reliable operation

### Application Parameter Presets

- ▶ A1000 automatically sets parameters needed for major applications. Selecting the appropriate application optimizes the drive for top performance, while saving time for set up.

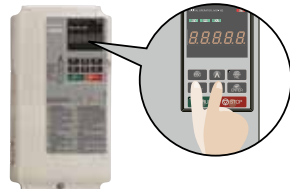
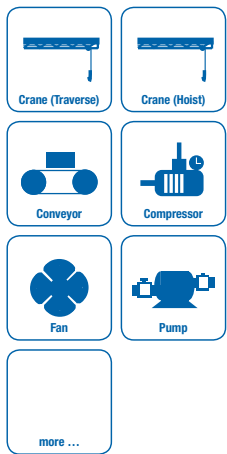

Setting	Setting
00	General-purpose
01	Water Supply Pump
02	Conveyor
03	Exhaust Fan
04	HVAC Fan
05	Air Compressor
06	Crane (Hoist)
07	Crane (Traverse)

**Parameters are programmed automatically**

A1-02	Control mode selection
C1-01	Accel Time 1
C1-02	Decel Time
C6-01	ND/HD Selection

**Example using Application Presets**  
 Selecting "Conveyor" optimizes parameter settings so the drive is ready to start your conveyor application immediately

### Multifunction Terminal Block

- ▶ The first terminal board with a Parameter Backup Function  
 The terminal block's ability to save parameter setting data makes it easy to get the application back online in the event of a failure requiring drive replacement.

**A1000 Terminal Block**



Parameter		
Name	Number	Setting
ND/HD	C6-01	1
Control Mode	A1-02	0
Frequency Reference Selection	b1-01	1
Run Command Selection	b1-02	1



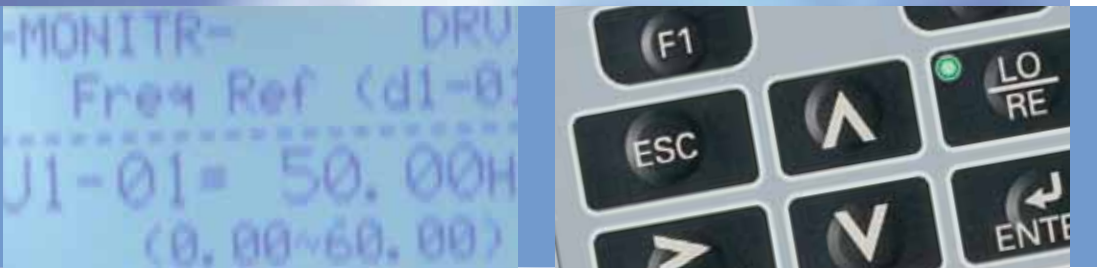

## Parameter Copy Function

- ▶ All standard models are equipped with a Parameter Copy Function that allows parameter settings to be easily copied from the drive or uploaded for quick setup using the operator.
- ▶ A USB Copy Unit is also available as an even faster, more convenient way to back up settings and instantly program the drive.



## Engineering Tool DriveWizard Plus

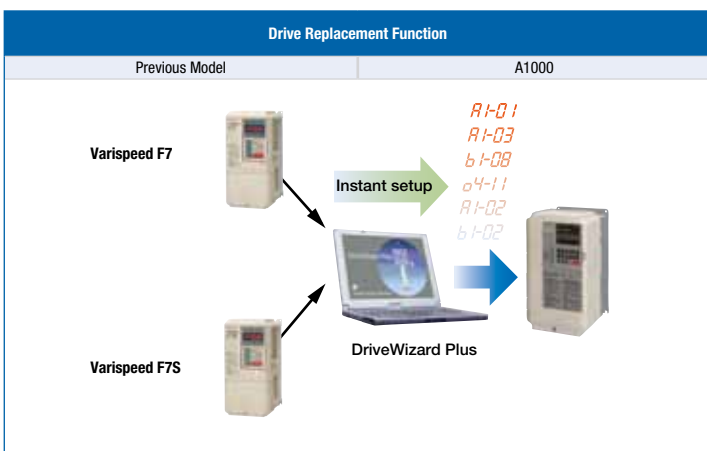

**Note:** To obtain a copy of DriveWizard Plus, contact a YASKAWA representative.

- ▶ Engineering Tool DriveWizard Plus
- ▶ Manage the unique settings for all your drives right on your PC.
- ▶ An indispensable tool for drive setup and maintenance. Edit parameters, access all monitors, create customized operation sequences, and observe drive performance with the oscilloscope function.
- ▶ The Drive Replacement feature in DriveWizard Plus saves valuable time during equipment replacement and application upgrades by converting previous YASKAWA product parameter values to the new A1000 parameters automatically.

# Drive Design & Features

## Even More Compact

- ▶ YASKAWA continues to make applications even smaller by combining the compact designed drive with the light, efficient design of a synchronous motor.
- ▶ Use Side-by-Side installation for an even more compact setup.
- ▶ Finless models available\*.

\* Coming soon

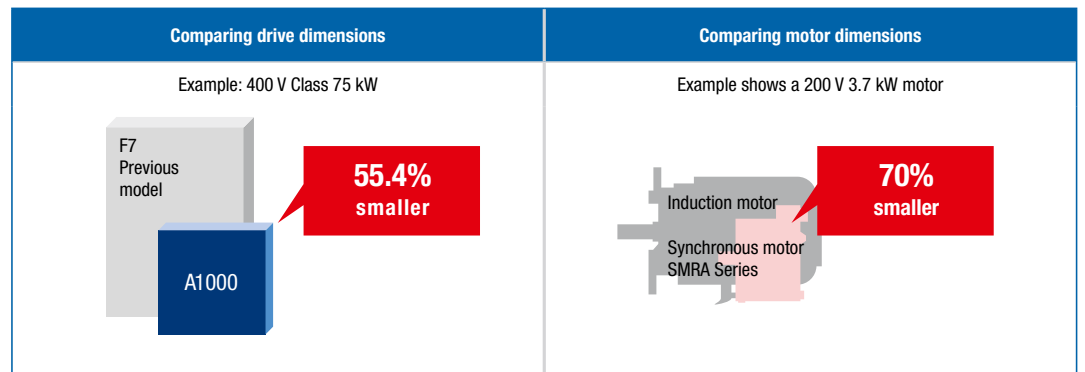

## Dual Rating for Cost & Space Saving

- ▶ Each drive lets the user choose between Normal Duty or Heavy Duty operation. Depending on the application, A1000 can run a motor an entire frame size larger than our previous model.

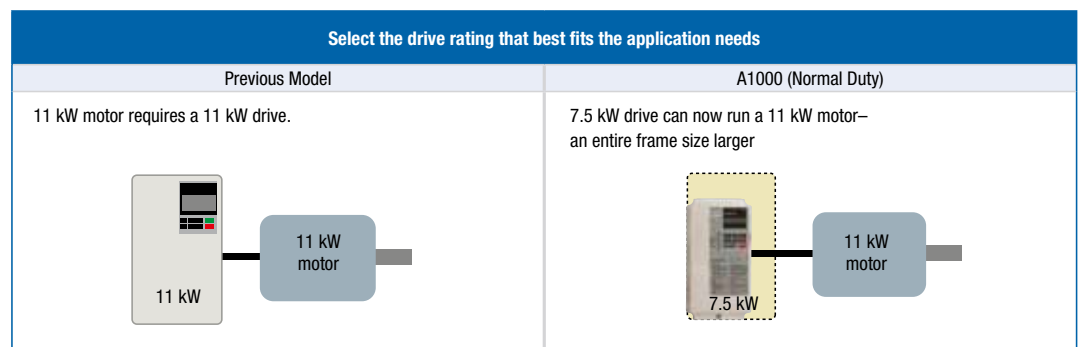

Dual Ratings in A1000

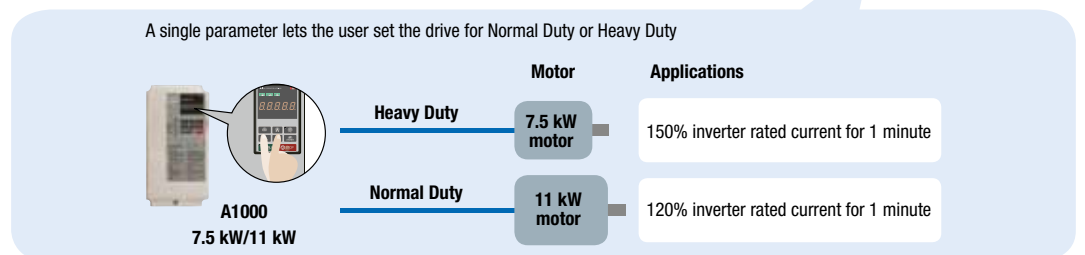

**Note:** Always select a drive with a current rating greater than the motor rated current.



## Long Performance Life

- ▶ Designed for 10 years of maintenance-free operation. Cooling fan, capacitors, relays, and IGBTs have been carefully selected and designed for a life expectancy up to ten years.\*



\* Assumes the drive is running continuously for 24 hours a day at 80% load with an ambient temperature of 40°C.

## Performance Life Monitors

- ▶ YASKAWA's latest drive series is equipped with performance life monitors that notify the user of part wear and maintenance periods to prevent problems before they occur.

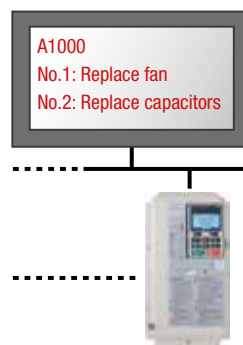

Operator Display	Corresponding Component
LT-1	Cooling fan
LT-2	Capacitors
LT-3	Inrush prevention relay
LT-4	IGBTs

Drive outputs a signal to the control device indicating components may need to be replaced

## Variety of Braking Functions

- ▶ Overexcitation deceleration capabilities bring the motor to a quick stop without the use of a braking resistor.
- ▶ All models up to 30 kW (HD) are equipped with a braking transistor for even more powerful braking options by just adding a braking resistor.

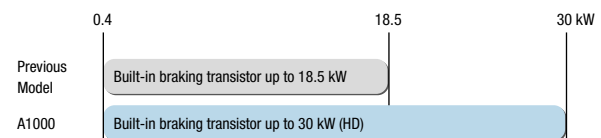

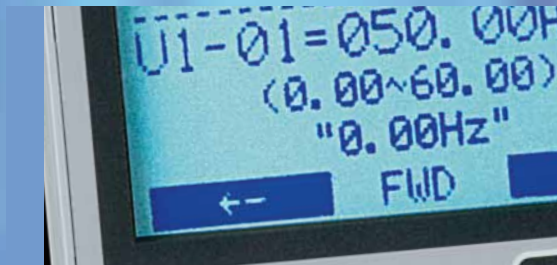

## Efficiency & Environment

### Energy Saving

- ▶ Loaded with advanced energy-saving control technology. Energy-Saving control makes highly efficient operation possible with an induction motor.
- ▶ Amazing energy saving with a synchronous motor. Combining the high efficiency of a synchronous motor along with A1000's Energy-Saving control capabilities allows for unparalleled energy saving.

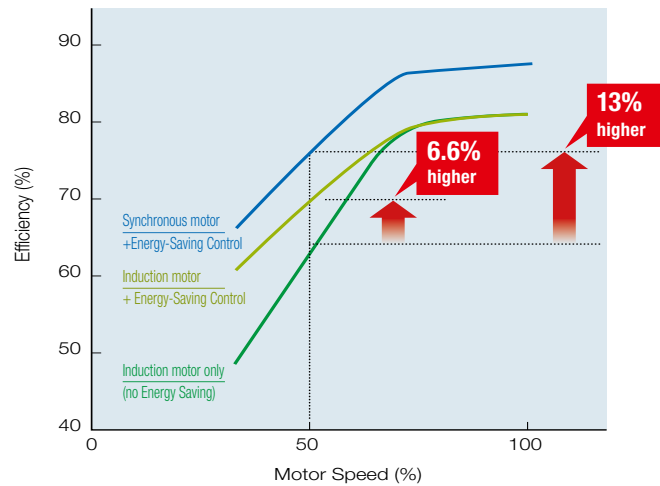

**Conditions:**  
 Annual energy savings for an HVAC fan application running 100 3.7 kW motors. Electric costs of 8 cents/kWh\*, Average industrial electric costs in Europe

Examples of energy saving with A1000 and PM Motor		
	Power consumption	Electrical costs
A Induction motor + A1000	1,903,100 kWh	€ 152,300
B IPM motor + A1000	1,754,600 kWh	€ 140,400
Annual savings on energy costs: [A] vs. [B]	148,500 kWh	€ 11,900
Annual reduction in CO <sub>2</sub>	148,500 kWh x 0.555 ÷ 1,000 =	82.4 tons!
Assumes 1 kW of power consumed creates 0.555 kg/kWh of CO <sub>2</sub>		

**Total Energy Savings**  
**€11,900**

**Efficiency with energy saving function**  
 Example shows a 200 V 4.0 kW drive in a fan or pump application

### Noise Reduction

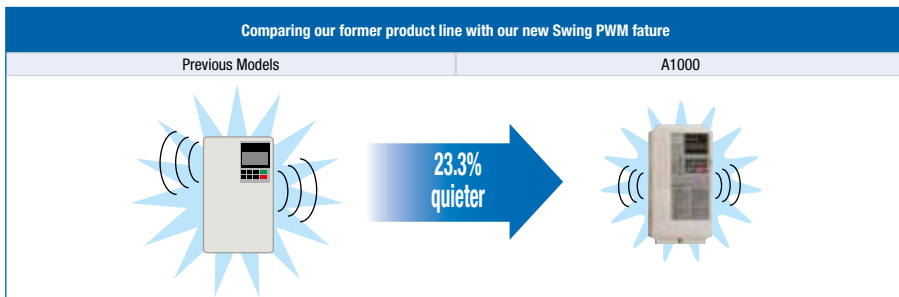

**Note:**  
 Calculated by comparing peak values during noise generation

- ▶ A1000 uses YASKAWA Swing PWM function to suppress electromagnetic and audible motor noise, creating a more peaceful environment.



## Standard Specifications

	Item	Specifications
Control Characteristics	Control Method	V/f Control, V/f Control with PG, Open Loop Vector Control, Closed Loop Vector Control, Open Loop Vector for PM, Closed Loop Vector for PM, Advanced Open Loop Vector for PM
	Frequency Control Range	0.01 to 400 Hz
	Frequency Accuracy (Temperature Fluctuation)	Digital reference: within $\pm 0.01\%$ of the max. output frequency ( $-10$ to $+40^{\circ}\text{C}$ ) Analog reference: within $\pm 0.1\%$ of the max. output frequency ( $25^{\circ}\text{C} \pm 10^{\circ}\text{C}$ )
	Frequency Setting Resolution	Digital reference: 0.01 Hz Analog reference: 0.03 Hz / 60 Hz (11 bit)
	Output Frequency Resolution	0.001 Hz
	Frequency Setting Signal	$-10$ to $+10$ V, $0$ to $+10$ V, $4$ to $20$ mA, Pulse Train
	Starting Torque	150%/3 Hz (V/f Control and V/f Control with PG), 200%/0.3 Hz*1 (Open Loop Vector Control), 200%/0 r/min <sup>-1</sup> (Closed Loop Vector Control, Closed Loop Vector Control for PM, and Advanced Open Loop Vector Control for PM), 100%/5% speed (Open Loop Vector Control for PM)
	Speed Control Range	1:1500 (Closed Loop Vector Control and Closed Loop Vector for PM) 1:200 (Open Loop Vector Control) 1:40 (V/f Control and V/f Control with PG) 1:20 (Open Loop Vector for PM) 1:100 (Advanced Open Loop Vector for PM)
	Speed Control Accuracy	$\pm 0.2\%$ in Open Loop Vector Control ( $25^{\circ}\text{C} \pm 10^{\circ}\text{C}$ ) <sup>2</sup> , $0.02\%$ in Closed Loop Vector Control ( $25^{\circ}\text{C} \pm 10^{\circ}\text{C}$ )
	Speed Response	10 Hz in Open Loop Vector ( $25^{\circ}\text{C} \pm 10^{\circ}\text{C}$ ), 50 Hz in Closed Loop Vector Control ( $25^{\circ}\text{C} \pm 10^{\circ}\text{C}$ ) (excludes temperature fluctuation when performing Rotational Auto-Tuning)
	Torque Limit	All Vector Control allows separate settings in four quadrants
	Accel/Decel Time	0.00 to 6000.0 s (4 selectable combinations of independent acceleration and deceleration settings)
	Protection Function	Braking Torque
V/f Characteristics		User-selected programs and V/f preset patterns possible
Main Control Functions		Torque control, Droop control, Speed/torque control switching, Feedforward control, Zero-servo control, Momentary power loss ride-thru, Speed search, Overtorque detection, Torque limit, 17-step speed (max), Accel/decel time switch, S-curve accel/decel, 3-wire sequence, Auto-tuning (rotational, stationary), Online tuning, Dwell, Cooling fan on/off switch, Slip compensation, Torque compensation, Frequency jump, Upper/lower limits for frequency reference, DC injection braking at start and stop, Overexcitation braking, High slip braking, PID control (with sleep function), Energy saving control, MEMOBUS comm. (RS-485/422 max, 115.2 kbps), Fault restart, Application presets, DriveWorksEZ (customized function), Removable terminal block with parameter backup function...
Operating Environment	Motor Protection	Motor overheat protection based on output current
	Momentary Overcurrent Protection	Drive stops when output current exceeds 200% of Heavy Duty Rating
	Overload Protection	Drive stops after 60 s at 150% of rated output current (Heavy Duty Rating) <sup>5</sup>
	Overvoltage Protection	200 V class: Stops when DC bus exceeds approx. 410 V, 400 V class: Stops when DC bus exceeds approx. 820 V
	Undervoltage Protection	200 V class: Stops when DC bus exceeds approx. 190 V, 400 V class: Stops when DC bus exceeds approx. 380 V
	Momentary Power Loss Ride-Thru	Immediately stop after 15 ms or longer power loss. Continuous operation during power loss of less than 2 s (standard) <sup>6</sup>
	Heatsink Overheat Protection	Thermistor
	Braking Resistance Overheat Protection	Overheat sensor for braking resistor (optional ERF-type, 3% ED)
	Stall Prevention	Stall prevention during acceleration/deceleration and constant speed operation
	Ground Protection	Protection by electronic circuit <sup>7</sup>
Operating Environment	Charge LED	Charge LED remains lit until DC bus has fallen below approx. 50 V
	Area of Use	Indoors
	Ambient Temperature	$-10$ to $+50^{\circ}\text{C}$ (open chassis), $-10$ to $+40^{\circ}\text{C}$ (NEMA Type 1)
	Humidity	95% RH or less (no condensation)
	Storage Temperature	$-20$ to $+60^{\circ}\text{C}$ (short-term temperature during transportation)
	Altitude	Up to 1000 meters (output derating of 1% per 100 m above 1000 m, max. 3000 m)
	Shock	10 to 20 Hz: 9.8m/s <sup>2</sup> ; 20 to 55 Hz: 5.9 m/s <sup>2</sup> for 200 V up to 45 kW and 400 V up to 75 kW, 2.0 m/s <sup>2</sup> for 200 V, 55 to 110 kW and 400 V, 90 to 315 kW
	Standards	CE, UL, cUL, RoHS
Protection Design	IP00 open-chassis, IP20, NEMA Type 1 enclosure	

\*1: Requires a drive with recommended capacity.

\*2: Speed control accuracy may vary slightly depending on installation conditions or motor used. Contact YASKAWA for details.

\*3: Instantaneous average deceleration torque refers to the torque required to decelerate the motor (uncoupled from the load) from the rated motor speed down to zero in the shortest time.

\*4: If L3-04 is enabled when using a braking resistor or braking resistor unit, the motor may not stop within the specified deceleration time.

\*5: Overload protection may be triggered at lower levels if output frequency is below 6 Hz.

\*6: Varies in accordance with drive capacity and load. Drives with a capacity of smaller than 11 kW in the 200 V (model: CIMR-AC2A0056) or 400 V (model: CIMR-AC4A0031) require a separate Momentary Power Loss Recovery Unit to continue operating during a momentary power loss of 2 s or longer.

\*7: Ground protection cannot be provided when the impedance of the ground fault path is too low, or when the drive is powered up while a ground fault is present at the output.



# Connection Diagram

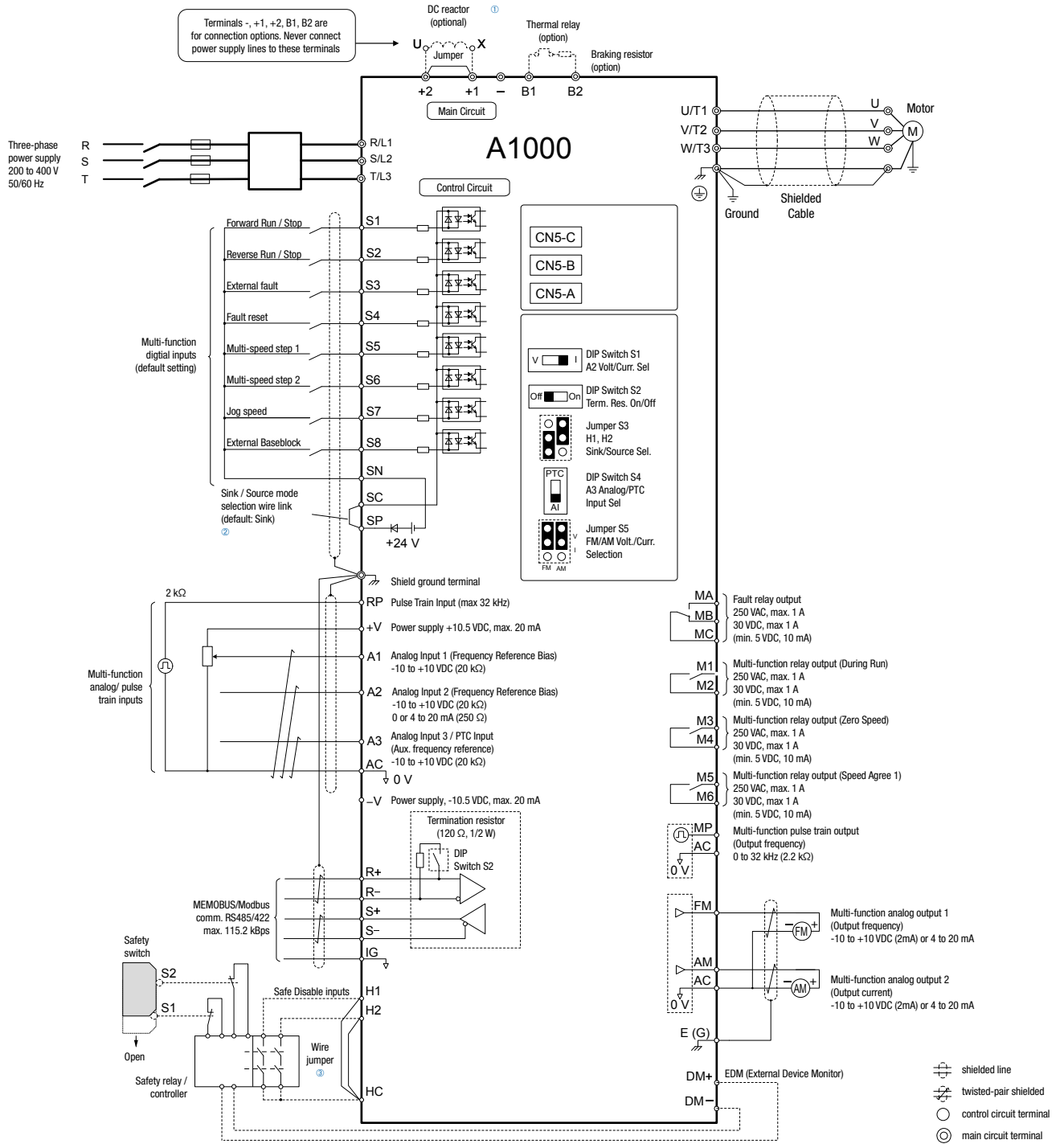

# A1000

## Terminal Functions

### Main Circuit Terminals

Terminal		Type				Function
200 V Class	Model	2A0004 to 2A0081	2A0110, 2A0138	2A0169 to 2A0415	–	
400 V Class	CIMR-A □	4A0002 to 4A0044	4A0058 to 4A0072	4A0088 to 4A0675	4A0930, 4A1200	
R/L1		Main circuit power supply input				Connects line power to the drive
S/L2						
T/L3						
R1-L11		not available		Main circuit power S1-L21 supply input		
S1-L21						
T1-L31						
U/T1		Drive output				Connects to the motor
V/T2						
W/T3						
B1		Braking resistor		not available		Available for connecting a braking resistor or a braking resistor unit option
B2						
⊕2		<ul style="list-style-type: none"> <li>DC reactor connection (⊕1, ⊕2) (remove the shorting bar between ⊕1 and ⊕2)</li> <li>DC power supply input (⊕1, ⊕)</li> </ul>	not available		<ul style="list-style-type: none"> <li>DC power supply input (⊕1, ⊕)</li> <li>Braking unit connection (⊕3, ⊖)</li> </ul>	For connection <ul style="list-style-type: none"> <li>of the drive to a DC power supply (terminals ⊕1 and ⊖ are not EU or UL approved)</li> <li>of dynamic braking options</li> <li>of a DC reactor</li> </ul>
⊕1						
⊖		not available				Grounding terminal
⊕3						
⊕		–				

### Control Circuit Terminals (200 V/400 V Class)

Type	Terminal	Terminal Name (Function)	Function (Signal Level) Default Setting
Safe Disable Inputs	H1	Safe Disable input 1	24 VDC, 8 mA
	H2	Safe Disable input 2	One or both open: Drive output disabled; Both closed: Normal operation; Internal impedance: 3.3 kΩ; Off time of at least 1 ms; Disconnect the wire jumpers shorting terminals H1, H2, and HC to use the Safe Disable inputs. Set the S3 jumper to select between sinking, sourcing mode, and the power supply.
	HC	Safe Disable function common	Safe disable function common
Analog Inputs / Pulse Train Input	RP	Multi-function pulse train input (Frequency reference)	Input frequency range: 0 to 32 kHz; Signal Duty Cycle: 30 to 70%; High level: 3.5 to 13.2 VDC, low level: 0.0 to 0.8 VDC; Input impedance: 3 kΩ
	+V	Power supply for analog inputs	10.5 VDC (max allowable current 20 mA)
	-V	Power supply for analog inputs	-10.5 VDC (max allowable current 20 mA)
	A1	Multi-function analog input 1 (Frequency reference bias)	-10 to 10 VDC, 0 to 10 VDC (input impedance: 20 kΩ)
	A2	Multi-function analog input 2 (Frequency reference bias)	-10 to 10 VDC, 0 to 10 VDC (input impedance: 20 kΩ) 4 to 20 mA, 0 to 20 mA (input impedance: 250 Ω)
	A3	Multi-function analog input 3 / PTC Input (Auxiliary frequency reference)	-10 to 10 VDC, 0 to 10 VDC (input impedance: 20 kΩ); Use switch S4 on the control terminal board to select between analog input or PTC input. If PTC is selected, set H3-06 = E.
	AC	Frequency reference common	0 V
Multi-Function Digital Inputs	E(G)	Ground for shielded lines and option cards	-
	S1	Multi-function input 1 (Closed: Forward Run, Open: Stop)	Photocoupler 24 VDC, 8 mA; Set the wire jumper between SC and SN or SC and SP for selection of sinking/sourcing mode and power supply.
	S2	Multi-function input 2 (Closed: Reverse Run, Open: Stop)	
	S3	Multi-function input 3 (External fault, N.O.)	
	S4	Multi-function input 4 (Fault Reset)	
	S5	Multi-function input 5 (Multi-step speed reference 1)	
	S6	Multi-function input 6 (Multi-step speed reference 2)	
	S7	Multi-function input 7 (Jog reference)	
	S8	Multi-function input 8 (External baseblock)	
	SC	Multi-function input common	
SN	Digital input power supply 0 V		
SP	Digital input power supply +24VDC	24 VDC power supply for digital inputs, 150 mA max. Never short terminals SP and SN as doing so will damage the drive.	
Fault Relay	MA	N.O.	Dry contact, contact capacity 30 VDC, 10 mA to 1 A; 250 VAC, 10 mA to 1 A Minimum load: 5 VDC, 10 mA
	MB	N.C. output	
	MC	Fault output common	
Multi-Function Digital Output	M1	Multi-function digital output (During run)	Dry contact, contact capacity 30 VDC, 10 mA to 1 A; 250 VAC, 10 mA to 1 A Minimum load: 5 VDC, 10 mA
	M2		
	M3	Multi-function digital output (Zero speed)	
	M4		
	M5	Multi-function digital output (Speed agree 1)	
	M6		
Monitor Output	MP	Pulse train output (Output frequency)	32 kHz (max)
	FM	Analog monitor output 1 (Output frequency)	
	AM	Analog monitor output 2 (Output current)	-10 to +10 VDC, 0 to +10 VDC, or 4 to 20 mA Use jumper S5 on the control terminal board to select between voltage or current output at terminals AM and FM. Set parameters H4-07 and H4-08 accordingly when changing the jumper setting.
	AC	Monitor common	
Safety monitor output	DM+	Safety monitor output	Outputs status of Safe Disable function. Closed when both Safe Disable channels are closed. Up to +48 VDC 50 mA
	DM-	Safety monitor output common	

\* Sequence Input changes in accordance with the sinking mode/source mode selection.

### Serial Communication Terminals (200 V/400 V Class)

Classification	Terminal	Signal Function	Description	Signal Level
RS-485/422 Transmission	R+	MEMOBUS communications Read	When using RS-422 two wires communication, short-circuit between R+ and S+, R- and S-.	Differential input PHC isolation
	R-			
	S+	MEMOBUS communications send		Differential output PHC isolation
	S-			
	IG	Communications output		-



## Dimensions

### Enclosures

Enclosures of standard products vary depending on the model. Refer to the table below.

200 V Class																					
Model CIMR-AC2A □□□□		0004	0006	0008	0010	0012	0018	0021	0030	0040	0056	0069	0081	0110	0138	0169	0211	0250	0312	0360	0415
Max. Applicable Motor Capacity [kW]	Normal Duty	0.75	1.1	1.5	2.2	3	4.0	5.5	7.5	11	15	18.5	22	30	37	45	55	75	90	110	110
	Heavy Duty	0.4	0.75	1.1	1.5	2.2	3	4.0	5.5	7.5	11	15	18.5	22	30	37	45	55	75	90	110
Enclosure Panel [NEMA Type1]		Standard												on request						-	
Open-Chassis (IP00)		Without top and bottom covers												Standard						-	

400 V Class																											
Model CIMR-AC4A □□□□		0002	0004	0005	0007	0009	0011	0018	0023	0031	0038	0044	0058	0072	0088	0103	0139	0165	0208	0250	0296	0362	0414	0515	0675	0930	1200
Max. Applicable Motor Capacity [kW]	Normal Duty	0.75	1.5	2.2	3	4.0	5.5	7.5	11	15	18.5	22	30	37	45	55	75	90	110	132	160	185	220	250	355	500	630
	Heavy Duty	0.4	0.75	1.5	2.2	3	4.0	5.5	7.5	11	15	18.5	22	30	37	45	55	75	90	110	132	160	185	220	315	450	560
Enclosure Panel [NEMA Type1]		Standard												on request						-							
Open-Chassis (IP00)		Without top and bottom covers												Standard						-							

### Open-Chassis [IP00]

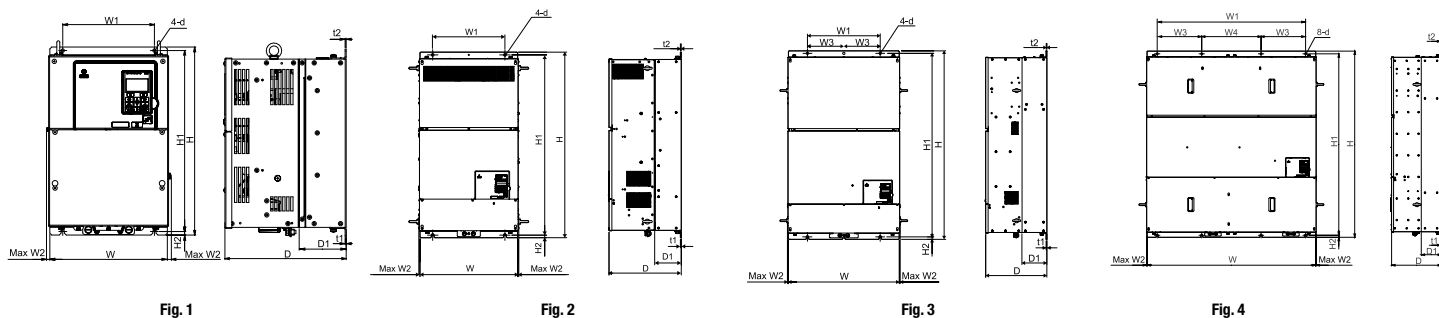

### 200 V Class

Model CIMR-AC2A □□□□	Max. applicable motor capacity [kW]		Figure	Dimensions in mm										Weight (kg)	Cooling
	Normal Duty	Heavy Duty		W	H	D	W1	H1	H2	D1	t1	t2	d		
0110	30	22	Fig. 1	250	400	258	195	385	7.5	100	2.3	2.3	4-M6	21	Fan cooled
0138	37	30		275	450		220	435						25	
0169	45	37		325	550		283	535						37	
0211	55	45		450	705	330	325	680	12.5	130	3.2	3.2	4-M10	76	
0250	75	55												80	
0312	90	75												98	
0360	110	90												99	
0415	110	110		500	800	350	370	773	13	130	4.5	4.5	4-M12	99	

### 400 V Class

Model CIMR-AC4A □□□□	Max. applicable motor capacity [kW]		Figure	Dimensions in mm										Weight (kg)	Cooling
	Normal Duty	Heavy Duty		W	H	D	W1	H1	H2	D1	t1	t2	d		
0058	30	22	Fig. 1	250	400	258	195	385	7.5	100	2.3	2.3	4-M6	21	Fan cooled
0072	37	30		275	450		220	435						25	
0088	45	37		325	510		283	260						495	
0103	55	45		325	510	283			535	110	2.3	41			
0139	75	55		450	705	330	325	680	12.5	130	3.2	3.2	4-M10	42	
0165	90	75												79	
0208	110	90												96	
0250	132	110												102	
0296	160	132	500	800	350	370	773	13	135	4.5	4.5	4-M12	107		
0362	185	160											125		
0414	220	185											125		
0515	250	220											216		
0675	355	315	Fig. 3	670	1140	370	440	1110	15	150	4.5	4.5	4-M12	221	
0930	500	450												545	
1200	630	560												555	



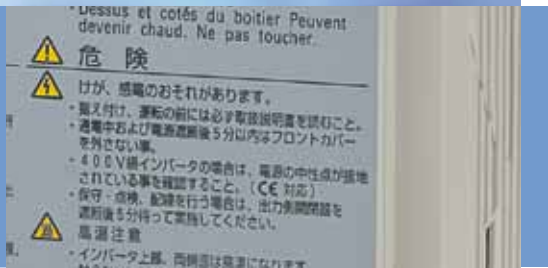

## Dimensions

### Enclosure NEMA Type 1

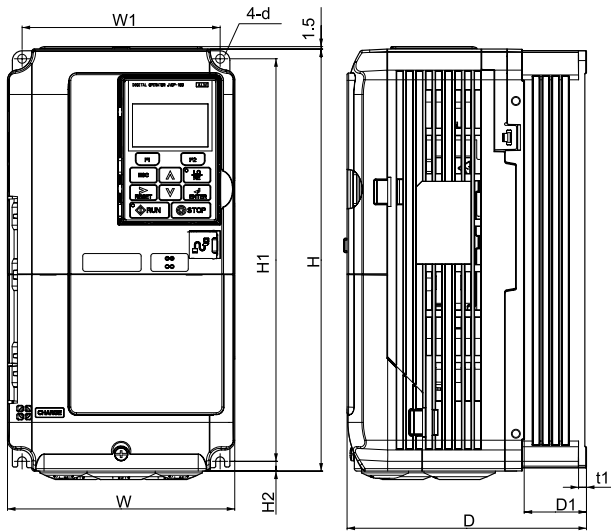

Fig. 1

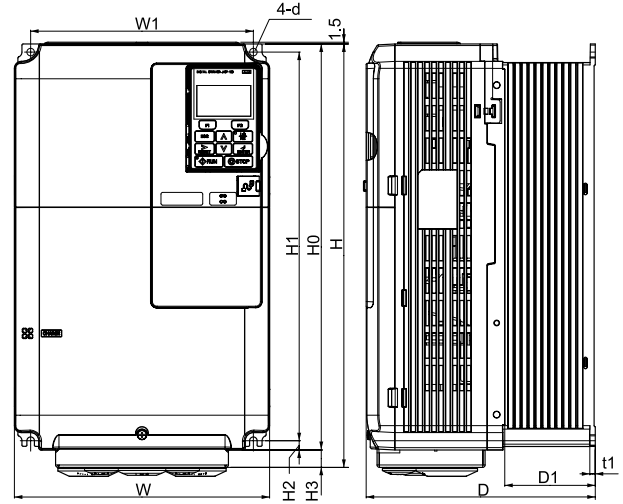

Fig. 2

### 200 V Class

Model CIMR-AC2A □□□□	Max. applicable motor capacity [kW]		Figure	Dimensions in mm												Weight (kg)	Cooling														
	Normal Duty	Heavy Duty		W	H	D	W1	H0	H1	H2	H3	D1	t1	t2	d																
0004	0.75	0.4	Fig. 1	140	260	147	122	-	248	6	-	-	38	5	-	4-M5	3.1	Self cooling													
0006	1.1	0.75																												3.2	
0010	2.2	1.5																													3.5
0012	3	2.2																													4.0
0021	5.5	4.0																													5.6
0030	7.5	5.5																													8.7
0040	11	7.5	Fig. 2	180	300	187	160	-	284	8	-	-	75	-	-	4-M6	5.6	Fan cooled													
0056	15	11																												8.7	
0069	18.5	15																													9.7
0081	22	18.5																													

### 400 V Class

Model CIMR-AC4A □□□□	Max. applicable motor capacity [kW]		Figure	Dimensions in mm												Weight (kg)	Cooling														
	Normal Duty	Heavy Duty		W	H	D	W1	H0	H1	H2	H3	D1	t1	t2	d																
0002	0.75	0.4	Fig. 1	140	260	147	122	-	248	6	-	-	38	5	-	4-M5	3.2	Self cooling													
0004	1.5	0.75																													3.4
0005	2.2	1.5																													3.5
0007	3	2.2																													3.9
0009	4.0	3																													5.4
0011	5.5	4.0																													5.7
0018	7.5	5.5																													8.3
0023	11	7.5																													
0031	15	11																													
0038	18.5	15																													
0044	22	18.5																													

# Options



Name	Purpose	Model	Model		
<b>Input Noise Filter</b>	Reduces noise from the line that enters into the drive input power system. Should be installed as close as possible to the drive. 400 V class: Filter of the manufacturer Block are used. Class C1 and footmounting up to 15 kW (HD), Class C2 and side mounting up to 110 kW (HD)	4A0002 □ AA	FB-40008A	4A0088 □ AA	FB-40105A
		4A0004 □ AA		4A0103 □ AA	
		4A0005 □ AA		4A0139 □ AA	FB-40170A
		4A0007 □ AA	4A0165 □ AA		
		4A0009 □ AA	FB-40014A	4A0208 □ AA	FB-40250A
		4A0011 □ AA	4A0250 □ AA		
		4A0018 □ AA	FB-40025A	4A0296 □ AA	FB-40414A
		4A0023 □ AA		4A0362 □ AA	
		4A0031 □ AA	FB-40044A	4A0414 □ AA	FB-40675A
		4A0038 □ AA	4A0515 □ AA		
		4A0044 □ AA	FB-40060A	4A0675 □ AA	FB-41200A
		4A0058 □ AA		4A0930 □ AA	
4A0072 □ AA	FB-40072A	4A1200 □ AA			
<b>AC Chokes</b>	Reducing Harmonics		B06040 Series		
<b>Analog input</b>	Enables high-precision and high-resolution analog speed reference setting. <ul style="list-style-type: none"> <li>Input signal level: -10 to +10 VDC (20 kΩ) 4 to 20 mA (500 Ω)</li> <li>Input channels: 3 channels, DIP switch for input voltage/input current selection</li> <li>Input resolution: Input voltage 13 bit signed (1/8192) Input current 1/6554</li> </ul>		AI-A3		
<b>Digital Input</b>	Enables 16-bit digital speed reference setting. <ul style="list-style-type: none"> <li>Input signal: 16 bit binary, 2 digit BCD + sign signal + set signal</li> <li>Input voltage: +24 V (isolated)</li> <li>Input current: 8 mA</li> </ul> Selectable Parameter: 8 bit, 12 bit, 16 bit		DI-A3		
<b>DeviceNet communications interface</b>	Used for running or stopping the drive, setting or referencing parameters and monitoring output frequency, output current, or similar items through DeviceNet communication with the host controller		SI-N3		
<b>CC-Link communications interface</b>	Used for running or stopping the drive, setting or referencing parameters and monitoring output frequency, output current, or similar items through CC-Link communication with the host controller.		SI-C3		
<b>CANopen communications interface</b>	Used for running or stopping the drive, setting or referencing parameters and monitoring output frequency, output current, or similar items through CANopen communication with the host controller.		SI-S3		
<b>MECHATROLINK communications interface</b>	Used for running or stopping the drive, setting or referencing parameters and monitoring output frequency, output current, or similar items through MECHATROLINK communication with the host controller.		SI-T3		
<b>PROFIBUS-DP communications interface</b>	Used for running or stopping the drive, setting or referencing parameters and monitoring output frequency, output current, or similar items through CANopen communication with the host controller.		SI-P3		
<b>Analog monitor</b>	Outputs analog signal for monitoring drive output state (output freq., output current etc.) <ul style="list-style-type: none"> <li>Output resolution: 11 bit signed (1/2048)</li> <li>Output voltage: -10 to +10 VDC (non-isolated)</li> <li>Output channels: 2 channels</li> </ul>		AO-A3		
<b>Digital output</b>	Outputs isolated type digital signal for monitoring drive run state (alarm signal, zero speed detection, etc.). Output channel: Photo coupler 6 channels (48 V, 50 mA or less) Relay contact output 2 channels 250 VAC, 1 A or less 30 VDC, 1 A or less		DO-A3		
<b>Open collector PG interface</b>	For control modes requiring a PG encoder for motor feedback. <ul style="list-style-type: none"> <li>Phase A, B, and Z pulse inputs (complementary type)</li> <li>PG frequency range: Approx. 50 kHz max.</li> <li>Pulse monitor output: Open collector, max. voltage: 24 V, max. current 30 mA</li> <li>Power supply output for PG: +12 V, max. current 200 mA</li> </ul>		PG-B3		
<b>Line Driver PG interface</b>	For control modes requiring a PG encoder for motor feedback. <ul style="list-style-type: none"> <li>Phase A, B, and Z pulse (differential pulse) inputs (RS-422)</li> <li>PG frequency range: up to 300 kHz (approx.)</li> <li>Pulse monitor output: RS-422</li> <li>Power supply output for PG: +5 V or +12 V, max. current 200 mA</li> </ul>		PG-X3		
<b>LED Operator</b>	Easy long distance reading		JVOP-182		
<b>Braking Resistor</b>	Used to shorten the deceleration time by dissipating regenerative energy through a resistor. (3% ED) (all models up to 3,7 kW)		ERF-150WJ series		
<b>Braking Chopper Unit</b>	Shortened deceleration time results when used with a Braking Transistor Unit.		CDBR series		
<b>24 V Power Supply</b>	Provides power supply for the control circuit and option boards. Note: Parameter settings cannot be changed when the drive is operating solely from this power supply.		PS-A10H PS-A10L		
<b>USB Copy Unit (RJ-45/USB compatible plug)</b>	<ul style="list-style-type: none"> <li>Adapter for connecting the drive to the USB port of a PC</li> <li>Can copy parameter settings easily and quickly to be later transferred to another drive.</li> </ul>		JVOP-181		
<b>LCD operator extension cable</b>	Cable for connecting the LCD operator.		WV001: 1 m WV003: 3 m		

Note: contact the manufacturer in question for availability and specifications of non-YASKAWA products.



## Ratings & Type Descriptions

### Model Number Key

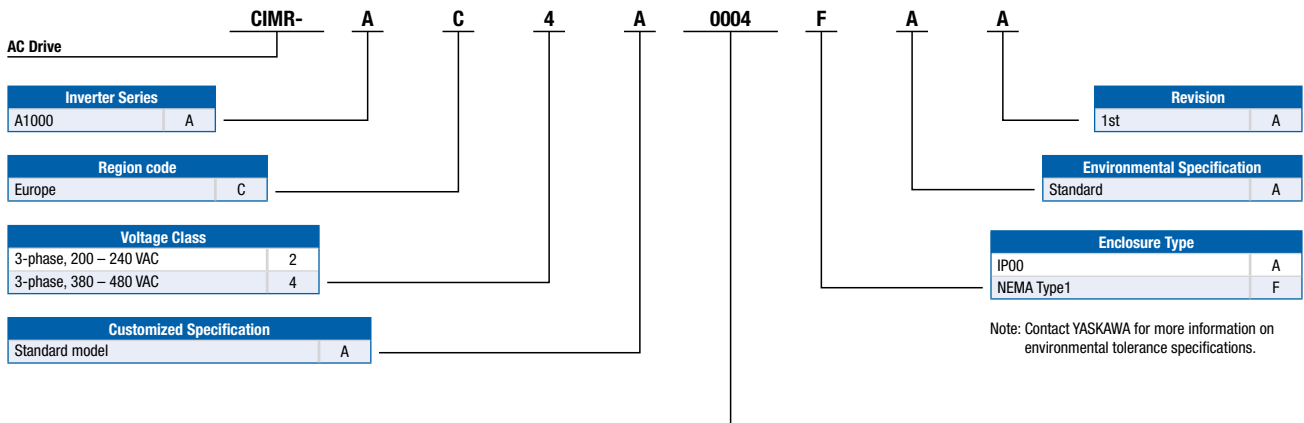

	200 V			
	Normal duty*1		Heavy duty	
	Rated output current [A]	Max. applicable motor*2 [kW]	Rated output current [A]	Max. applicable motor*2 [kW]
0004	3.5	0.75	3.2*3	0.4
0006	6	1.1	5*3	0.75
0010	9.6	2.2	8*3	1.5
0012	12	3	11*3	2.2
0021	21	5.5	17.5*3	4.0
0030	30	7.5	25*3	5.5
0040	40	11	33*3	7.5
0056	56	15	47*3	11
0069	69	18.5	60*3	15
0081	81	22	75*3	18.5
0110	110	30	85*3	22
0138	138	37	115*3	30
0169	169	45	145*4	37
0211	211	55	180*4	45
0250	250	75	215*4	55
0312	312	90	283*4	75
0360	360	110	346*4	90
0415	415	110	415*1	110

	400 V			
	Normal duty*1		Heavy duty	
	Rated output current [A]	Max. applicable motor*2 [kW]	Rated output current [A]	Max. applicable motor*2 [kW]
0002	2.1	0.75	1.8*3	0.4
0004	4.1	1.5	3.4*3	0.75
0005	5.4	2.2	4.8*3	1.5
0007	6.9	3	5.5*3	2.2
0009	8.8	4.0	7.2*3	3
0011	11.1	5.5	9.2*3	4.0
0018	17.5	7.5	14.8*3	5.5
0023	23	11	18*3	7.5
0031	31	15	24*3	11
0038	38	18.5	31*3	15
0044	44	22	39*3	18.5
0058	58	30	45*3	22
0072	72	37	60*3	30
0088	88	45	75*5	37
0103	103	55	91*3	45
0139	139	75	112*4	55
0165	165	90	150*4	75
0208	208	110	180*4	90
0250	250	132	216*4	110
0296	296	160	260*4	132
0362	362	185	304*4	160
0414	414	220	370*4	185
0515	515	250	450*1	220
0675	675	355	605*1	315
0930	930	500	810*1	450
1200	1200	630	1090*1	560

\*1: This value assumes a carrier frequency of 2 kHz. Increasing the carrier frequency requires a reduction in current.

\*2: The motor capacity (kW) refers to a YASKAWA 4-pole, 60 Hz, 200 V motor or 400 V motor. The rated output current of the drive output amps should be equal to or greater than the motor rated current.

\*3: This value assumes a maximum carrier frequency of 8 kHz. Increasing the carrier frequency requires a reduction in current.

\*4: This value assumes a maximum carrier frequency of 5 kHz. Increasing the carrier frequency requires a reduction in current.



**YASKAWA Europe GmbH**

Drives & Motion Division  
Hauptstr. 185  
65760 Eschborn  
Germany

+49 6196 569-300  
info@yaskawa.eu.com  
www.yaskawa.eu.com

International Standards



Safety Standards

Safety Stop

RoHS Directive

RoHS Directive stands for the EU directive on the restriction of the Use of Certain Hazardous Substances in Electrical and Electronic Equipment.